

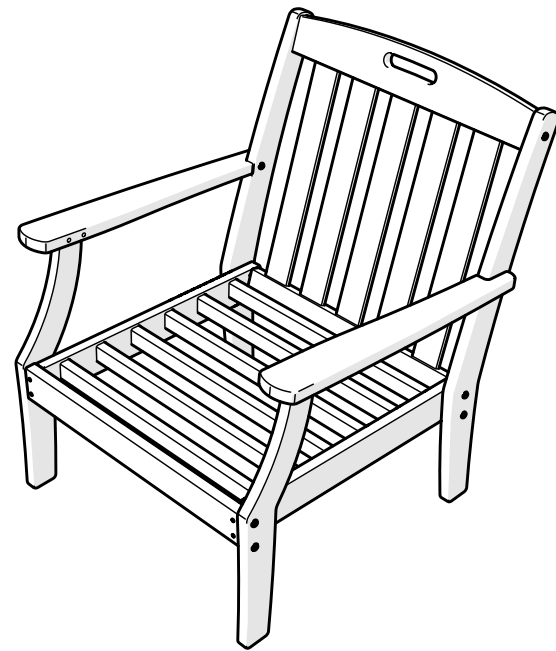

Assembly Instructions



TX4511X

Yacht Club Deep Seating Chair

..... 20-Year Warranty

To view our full warranty, please visit
trexfurniture.com/warranty

..... Share your space

We love to see where our furniture ends up — snap a pic and share it with us on Facebook!
facebook.com/trexfurniture

..... Having Trouble?

If you have questions or concerns regarding assembly instructions or missing parts, please contact us at **(877) 907-TREX (8739)** or email support@trexfurniture.com

..... Cleaning Tips

Keep your Trex Outdoor Furniture™ looking brand new:

For a quick clean:

Simply wipe down with soap and water.

For a deeper clean:

You'll need:

- » 1/3 bleach and 2/3 water solution
- » clean cloth
- » soft bristle brush

Wipe on solution with your cloth and let it sit on the lumber for a few minutes (this will not affect the color). Then, loosen any dirt and debris that may catch in surface grooves with a soft bristle brush; hose down to rinse.

TOOLS

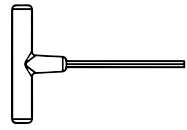

4mm T-handle hex key (included)

PARTS

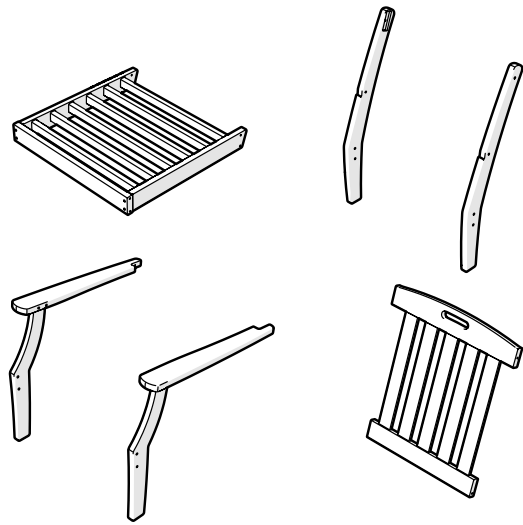

A x4

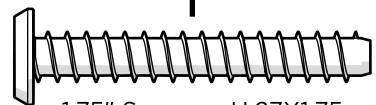

1.75" Screw — H.27X1.75

B x6

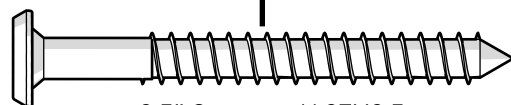

2.5" Screw — H.27X2.5

C x2

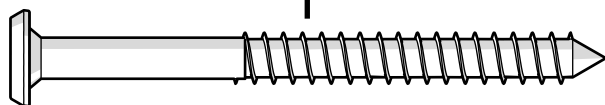

3" Screw — H.27X3

1

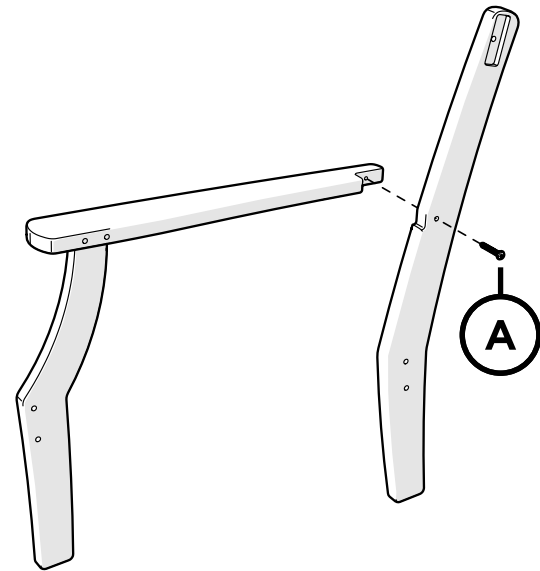

Repeat on opposite side

2

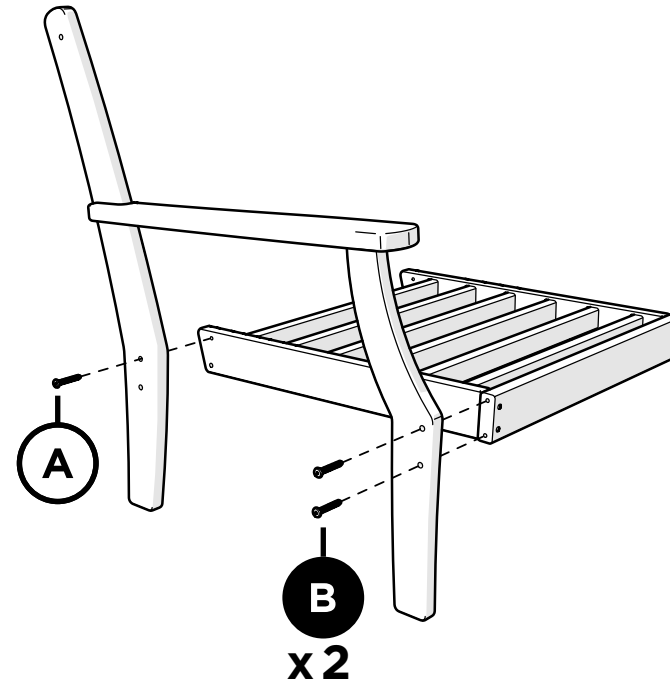

3

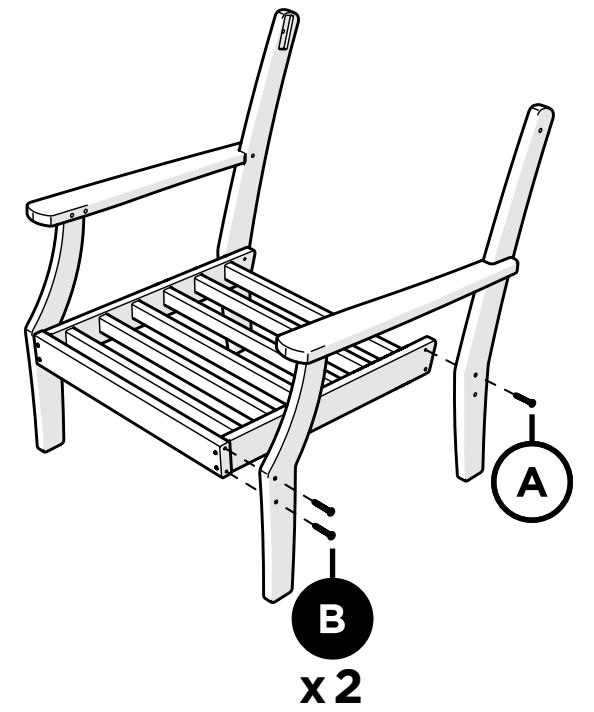

4

