

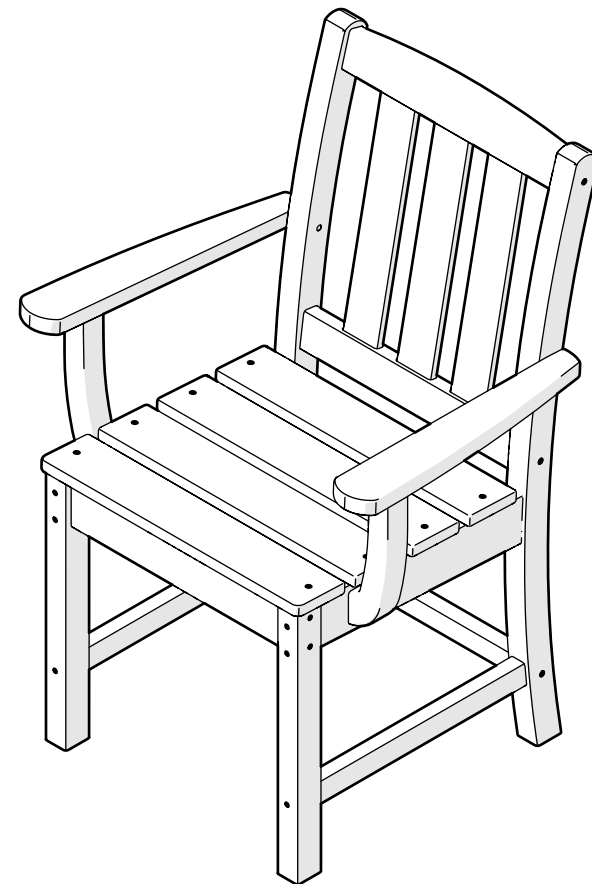

Assembly Instructions



TXTLD230
Cape Cod Dining
Arm Chair

..... **20-Year Warranty**

To view our full warranty, please visit
trexfurniture.com/warranty

..... **Share your space**

We love to see where our furniture
ends up — snap a pic and share
it with us on Facebook!
facebook.com/trexfurniture

..... **Having Trouble?**

If you have questions or concerns regarding
assembly instructions or missing parts,
please contact us at **(877) 907-TREX (8739)**
or email support@trexfurniture.com

..... **Cleaning Tips**

Keep your Trex Outdoor Furniture™
looking brand new:

For a quick clean:

Simply wipe down with soap and water.

For a deeper clean:

You'll need:

- » 1/3 bleach and 2/3 water solution
- » clean cloth
- » soft bristle brush

Wipe on solution with your cloth
and let it sit on the lumber for a few
minutes (this will not affect the color).
Then, loosen any dirt and debris that
may catch in surface grooves with a
soft bristle brush; hose down to rinse.

TOOLS

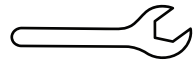

3/8" wrench
(not included)

PARTS

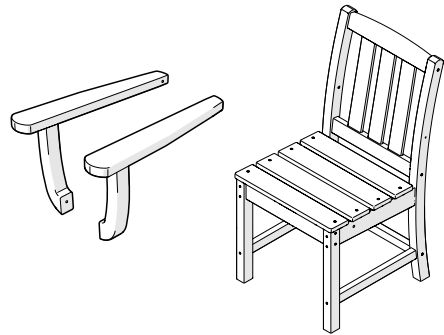

A x2

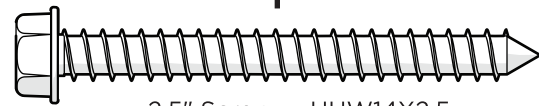

2.5" Screw — HHW14X2.5

B x2

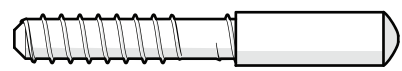

Cap Dowel Screw — HD.25X2+P11420

1

Twist dowel screw into arm until
finger-tight, remove protective cap

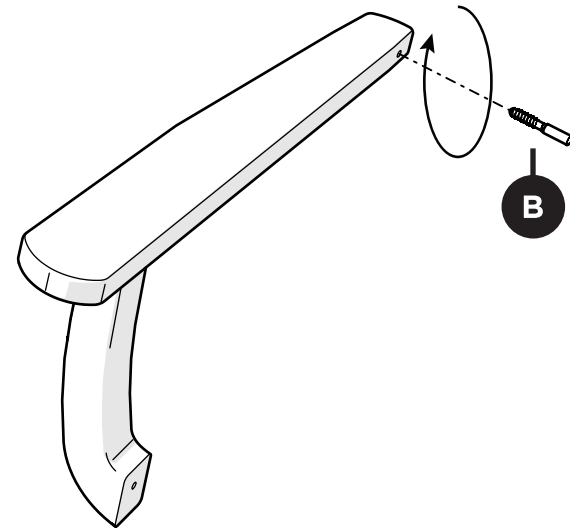

2

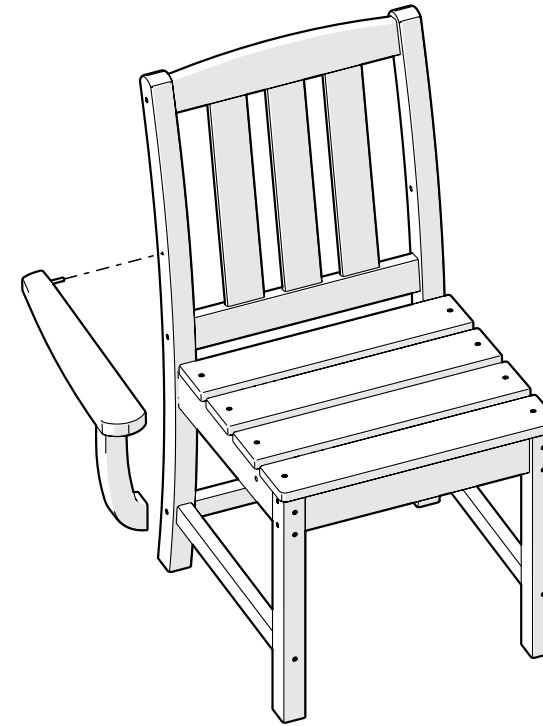

3

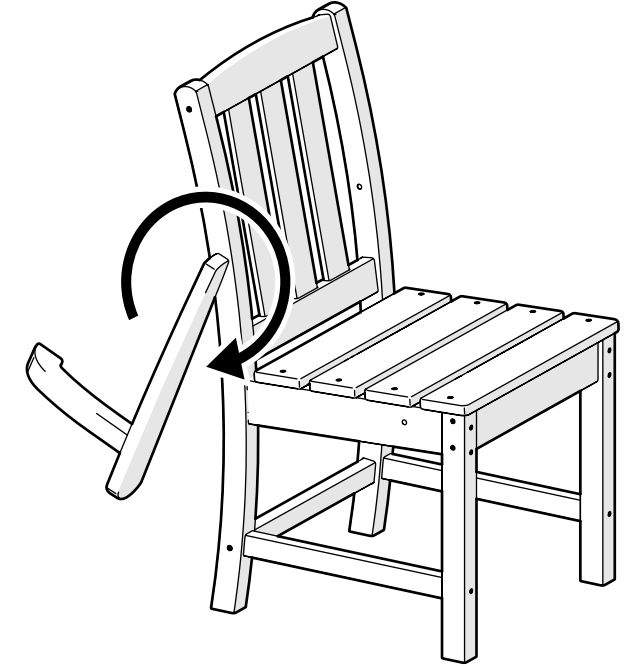

4

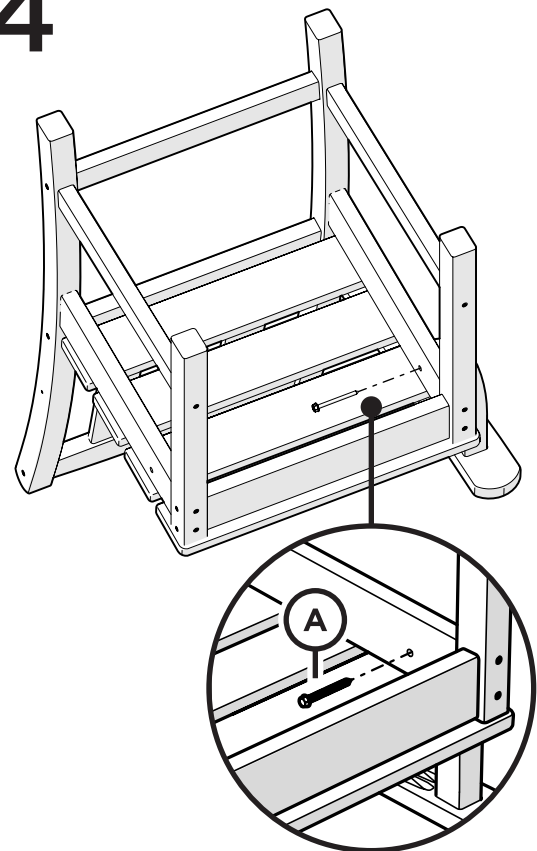

5

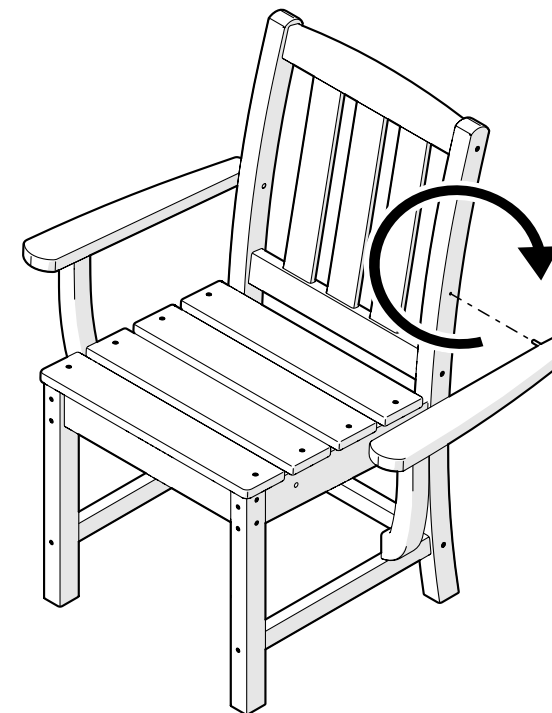

Repeat Steps 1 Thru 4
On Opposite Side

